

# Installation Instruction

LIGHT & GREENLLC

LG-5009

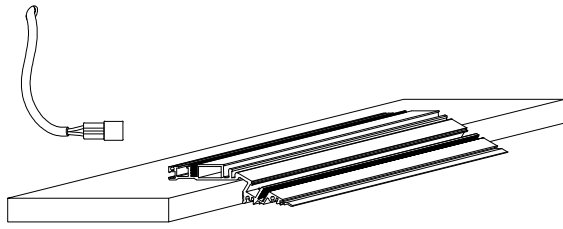

① Lay the profile knife cast

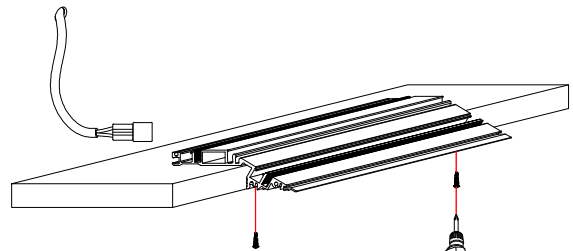

② Profile knife to strengthen plaster ceiling with screws

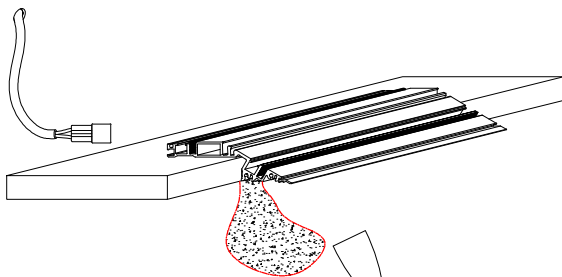

③ Fill the gap between plaster ceiling and profile knife

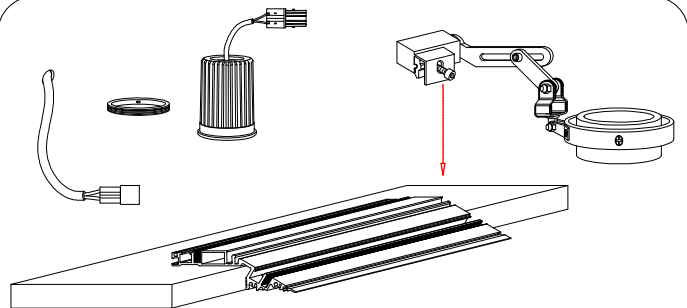

④ The arm

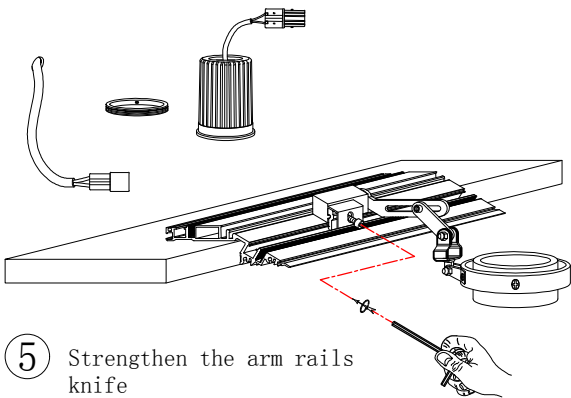

⑤ Strengthen the arm rails knife

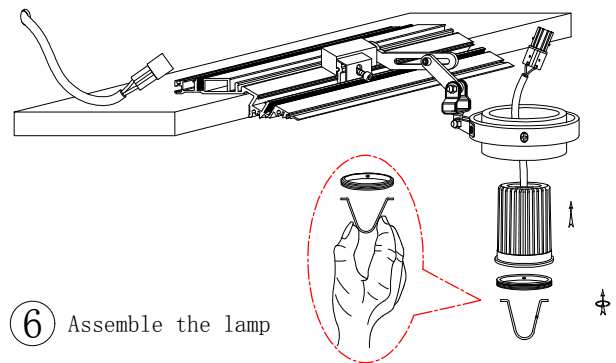

⑥ Assemble the lamp

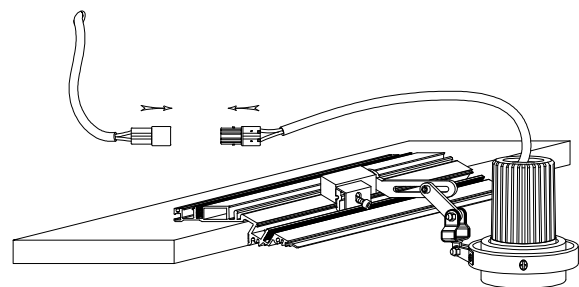

⑦ Connect the power cable to the cable lamp

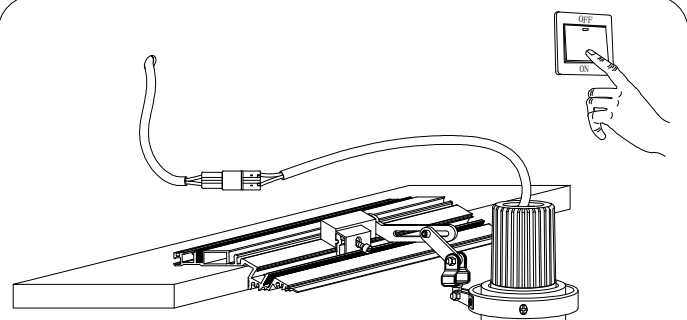

⑧ Turn on the light