

This trim have to use only with housing no.1002

1

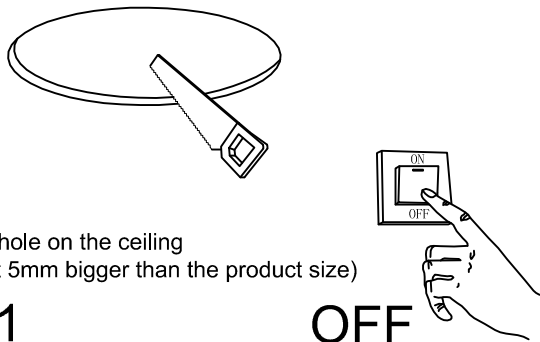

Cut a hole on the ceiling
(about 5mm bigger than the product size)

OFF

2

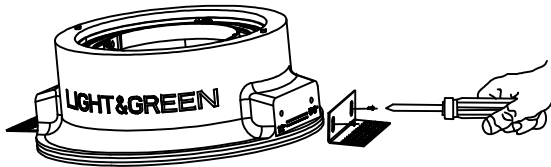

Lock the perforated bracket on trim
according to the thickness of the ceiling

3

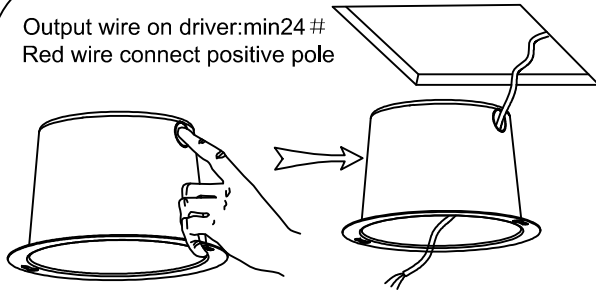

Output wire on driver:min24 #
Red wire connect positive pole

Black wire connect negative pole
Use current constant driver:500mA 36-42V

4

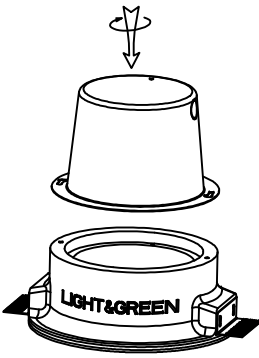

Fix the housing on the back side of the trim

5

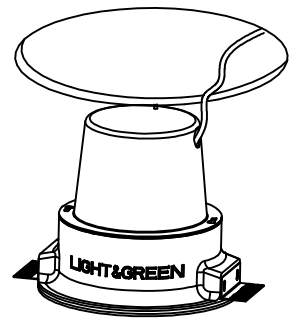

Put trim into the ceiling

6

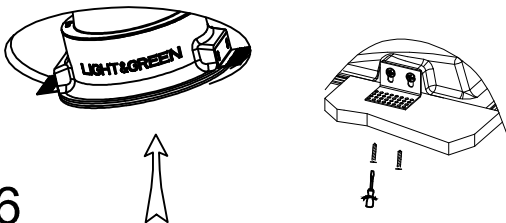

From the front,screw through the ceiling to fix the
perforated brackets ,then trim fixed on the ceiling

7

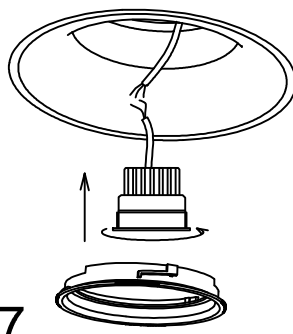

Connect driver with
the LED lamp

Red wire connect
positive pole

Black wire connect
negative pole

DC:36-42V.
Constant:500mA

8

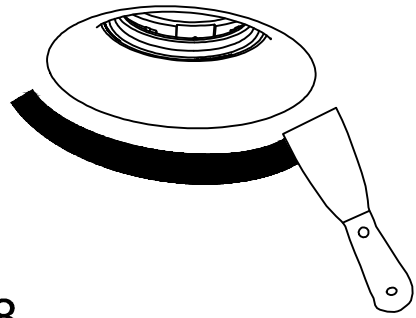

Fill the gap between the trim and ceiling

9

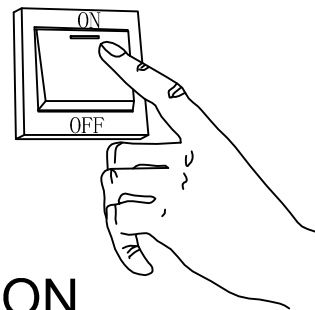

ON